

INSTALLATION GUIDELINES

Planning Information / AWPR PRESTIGE Series

AFIREWATER® water vapor fireplace modules are extremely easy to install, simple to operate, and easy to maintain. When designing your fireplace, feel free to send us your plans for review and comments.

Important Considerations:

- Determine best configuration for your installation:
(1) Recessed (2) Proud (in front of wall) (3) Free-Standing.
Note: If light cast upwards to ceiling is undesirable, create recessed hearth in wall for a traditional hearth appearance, or suspend a hood over the fireplace. (also see information how to create a 'light trap' in this document)
- Provide electrical power (120 V outlet) and 1/4" water line in cutout cavity if it is to be direct plumbed.
- For easy removal of fireplace and periodic maintenance, follow suggested clearances.
We recommend you do not install the units prior to completion of all construction to avoid construction debris and dust entering the unit which can cause problems with operation, and potentially damage components voiding the warranty. **(important)**
- Determine materials and finishes you expect to use; There are no issues created by heat, so choice of materials is limitless.
- Avoid placement where there are air currents from doors, windows, and from the HVAC system.
- Water Hardness: Only use moderately hard tap water between 3.5 to 8.5 Grains Per Gallon (7 is ideal). It's best to have water tested before prolonged use; excessively hard water will coat internal parts with calcium & mineral deposits and shorten life of equipment and possibly void the factory warranty.
Note: Do not use RO water (reverse osmosis). A moderate amount of minerals are needed to optimize flame effect. If water is too hard, use an inexpensive in-line water softener. Inexpensive hardness test kits are available on Amazon.
- Installing the water vapor insert:
Cutout dimensions are critical because modules suspend from the flanges that span the opening. Too small and fireplace will not fit; too large and fireplace module may fall thru the opening.
See 'How To' YouTube Videos: search for 'Lumina Products Inc' and then watch the AFIREWATER® PRESTIGE 'How To' Videos.
- Do not install fireplace until construction is complete. Equipment must be protected from dust and debris getting inside.
- Consult Owners Manual shipped with unit for more information.

Manual is also available online; our office can send you a link to the most recent version.

That's it! Enjoy an extraordinary fireplace experience every day of the year!

NOTE! Failure to follow these guidelines may diminish resulting flame effect, cause light to be cast onto ceiling, may cause excess light to 'bleed' into room. Installation must allow easy access and removal of units for maintenance.

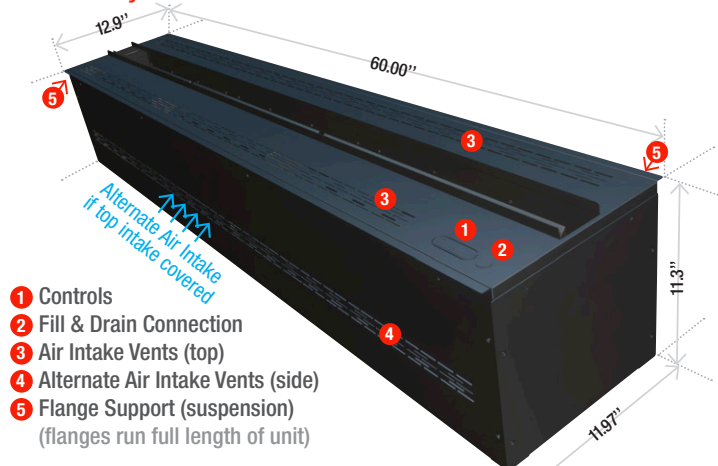
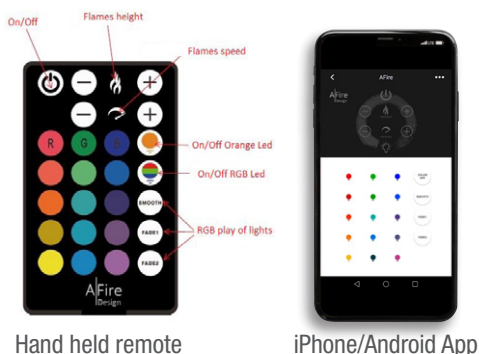

2

Note: Dimension in Plan View

These values have been calculated so that the light projected upwards is contained by the recessed light trap and do not shine up onto the ceiling of the room.

To increase height of hearth opening requires the depth of the hearth to be increased

See 68° and 53° light paths in Side Section below.

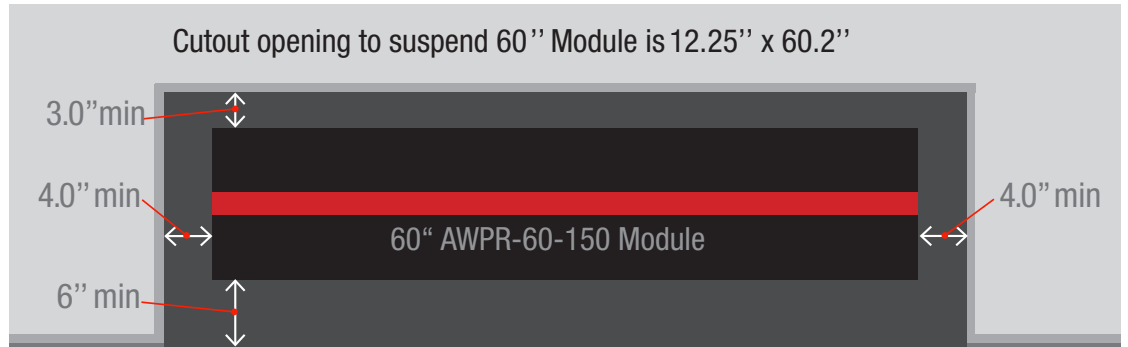

PLAN VIEW
SECTION THRU RECESSED HEARTH (A-A)

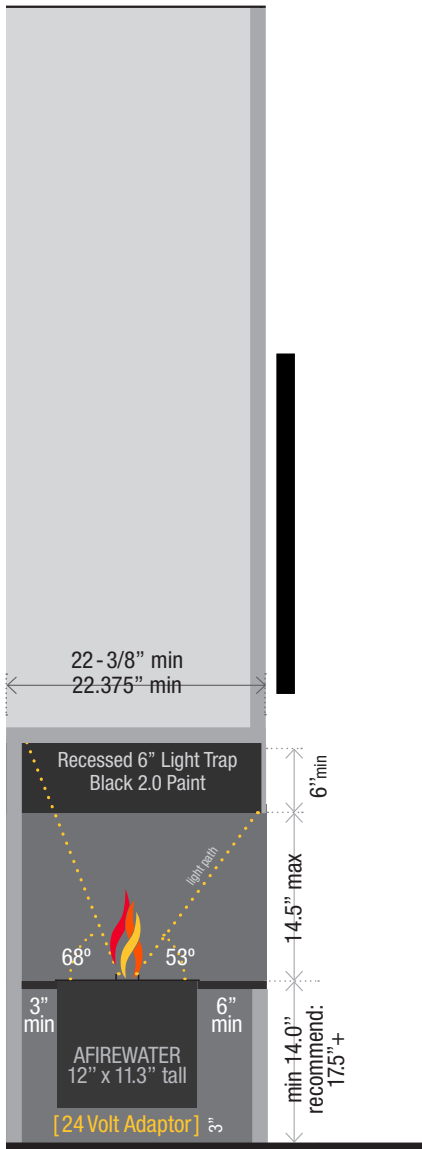

SIDE SECTION SCHEMATIC
RECESSED HEARTH

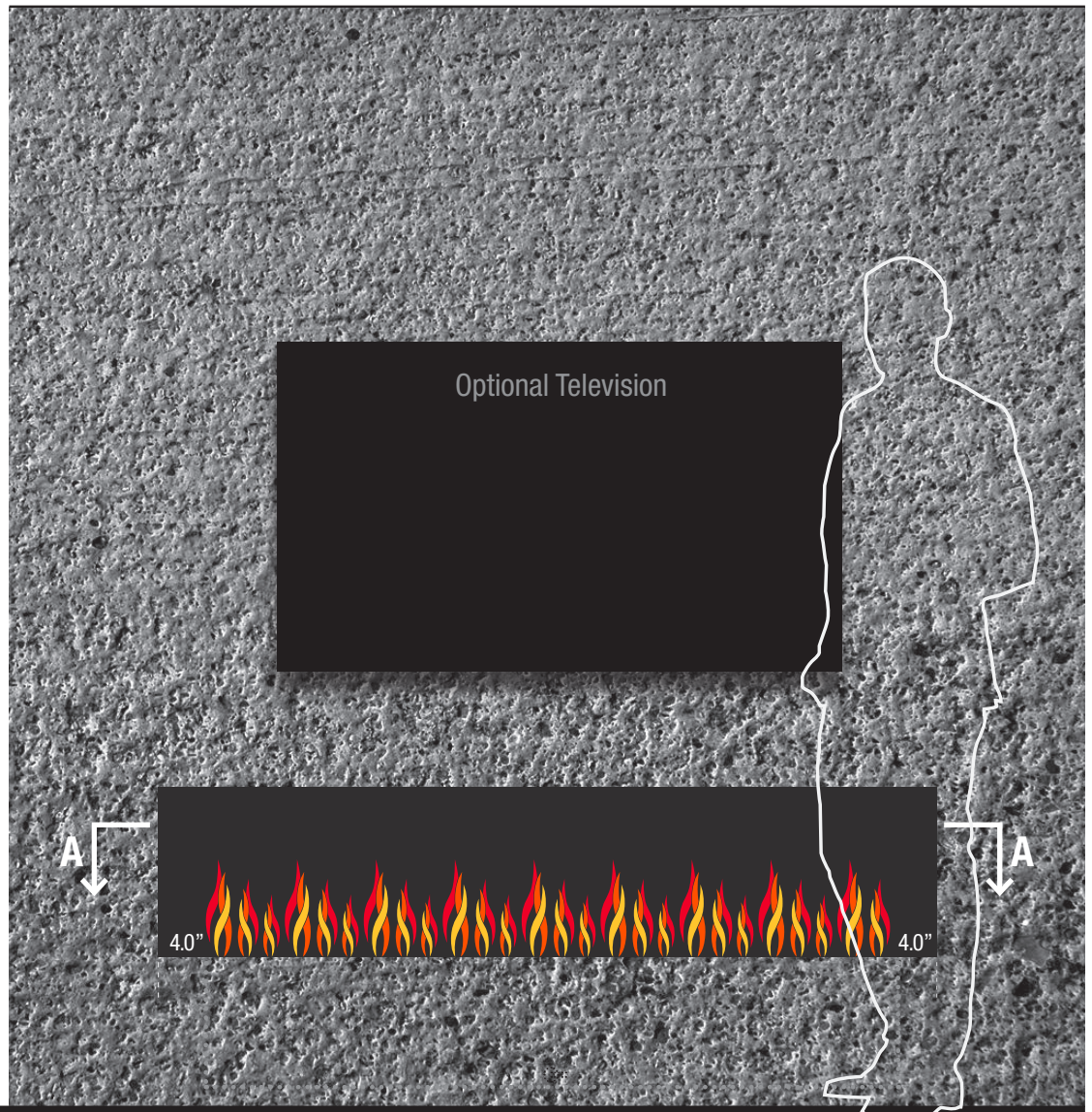

FRONT ELEVATION

3

For AFIREWATER PRESTIGE series 20" / 40" / 60" units

Type 1: Recessed Hearth

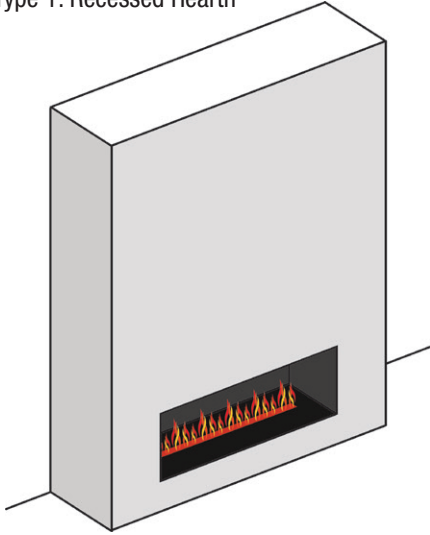

Type 2: Open Hearth (against wall)

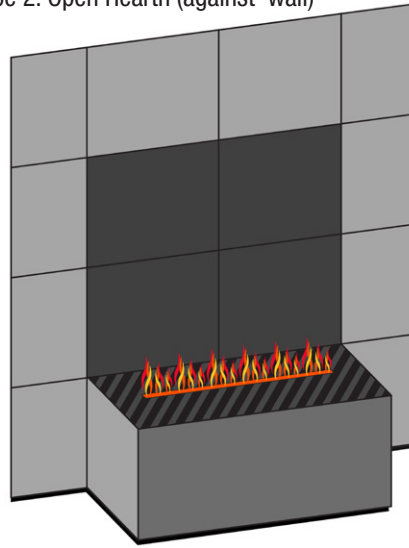

Type 3: Coffee Table (Fire Pit)

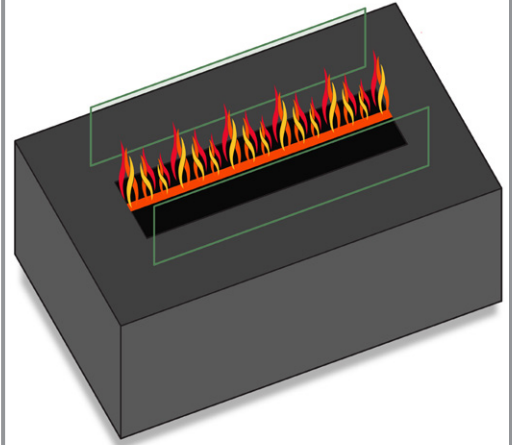

Type 4: Room Divider Floating Wall

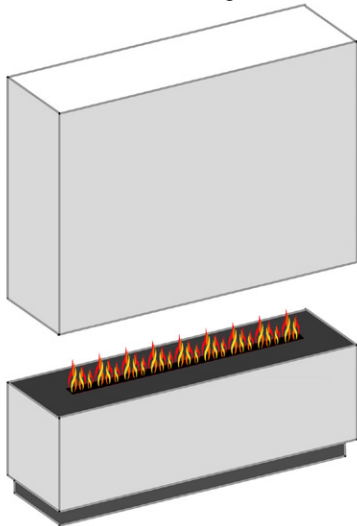

Type 5: Glass Enclosure

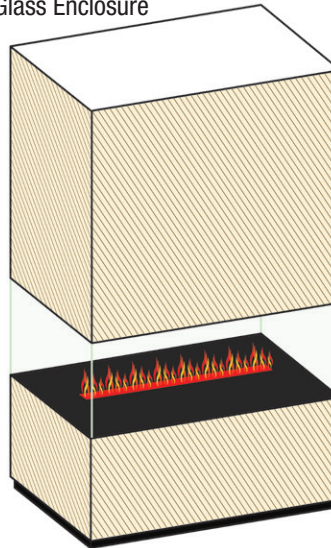

Type 6: Dining Table

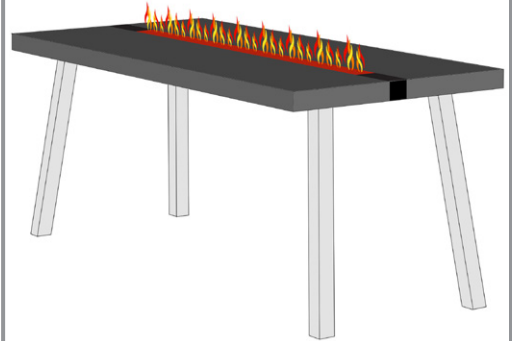

Type 7: Retrofit (traditional)

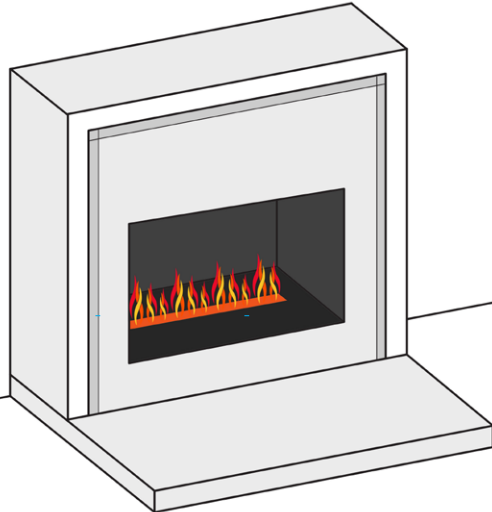

Type 8: Wall Hung

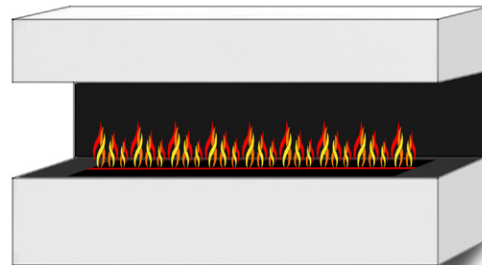

Type 9: 3-Sided Island

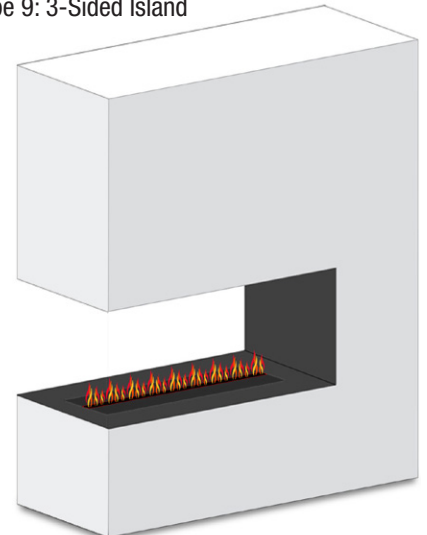

Important Notes for glass enclosed hearth:

- Only necessary when drafts or weather are an issue.
- Glass must not restrict airflow. Allow space for circulation into room.
- air must be able to flow in and out of enclosure.
- glass is optional and not required.

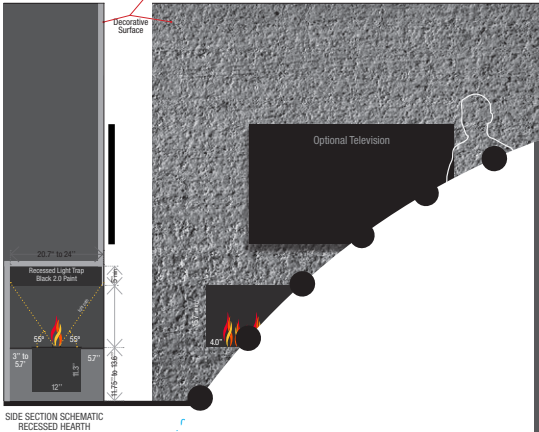
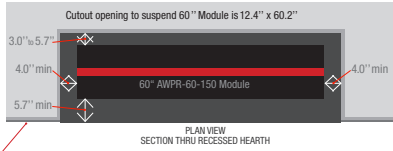

SIDE SECTION SCHEMATIC
GLASS ENCLOSED RECESSED HEARTH

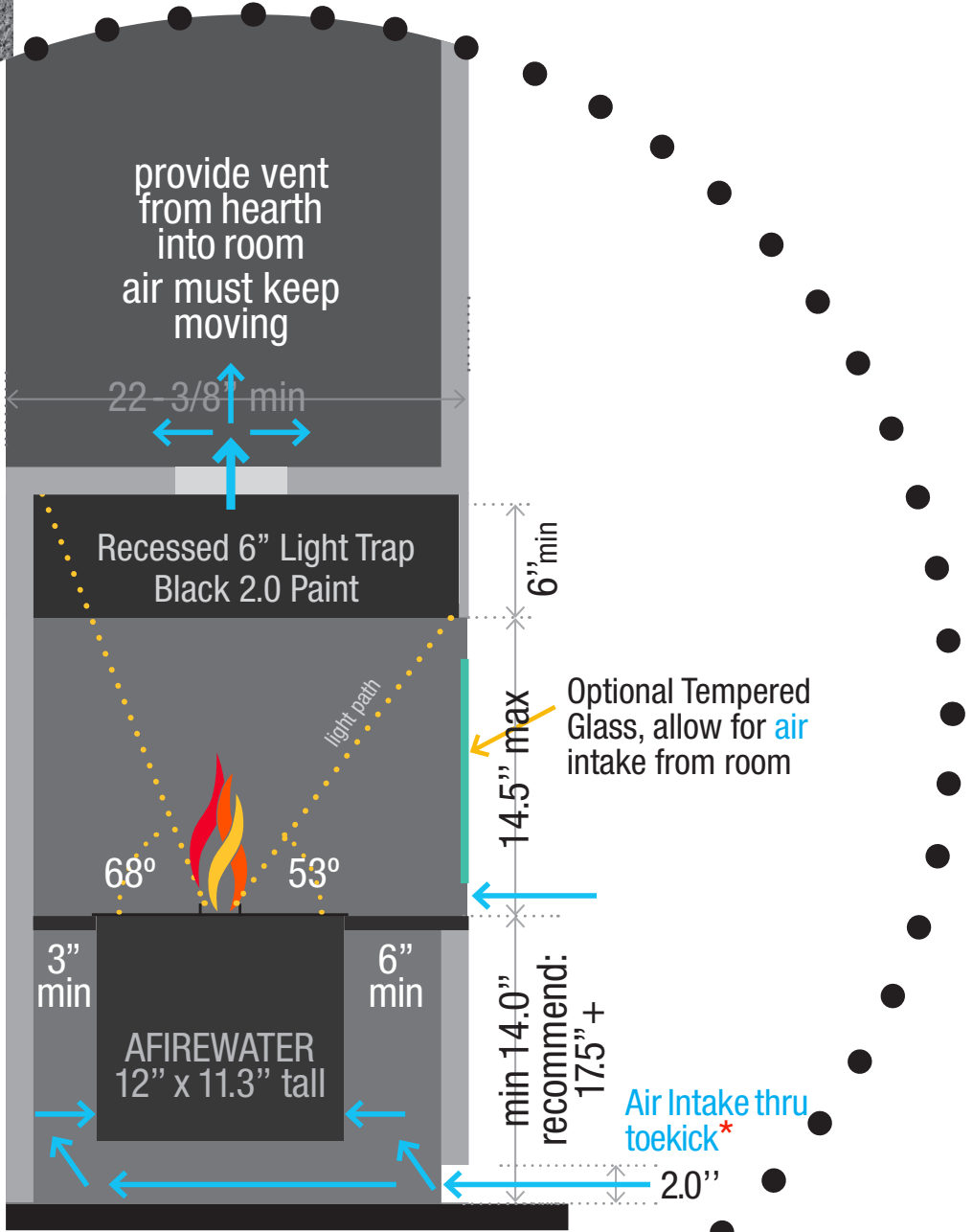

*
20" module requires 50 sq in of unrestricted air intake
40" module requires 100 sq in of unrestricted air intake
60" module requires 150 sq in of unrestricted air intake

ROOM DIVIDER EXAMPLE

OPEN ALL SIDES

Note: Overall dimensions of this example of a room divider fireplace is 78" wide x 20" deep. Hood extends 4" past fireplace base on both sides. In this case it is shown 9 feet tall. Configuration designed to minimize light that would otherwise be cast up to the ceiling in the room. The upper wall section is a large hollow hood painted inside with flat black paint. Optionally the top of the AFIREWATER® unit can be covered with granite or other decorative material. If so, then this AWPR 60-150-60" fireplace insert will require 150 sq in of unobstructed air intake thru the toe kick as shown in the schematic at the right. If a grill or grate covers the air intake you must compensate for the solid mass of the grill in your calculations. Do not cover the control buttons with stone. Stone should be easy to removal and allow the unit to be removed for service if necessary.

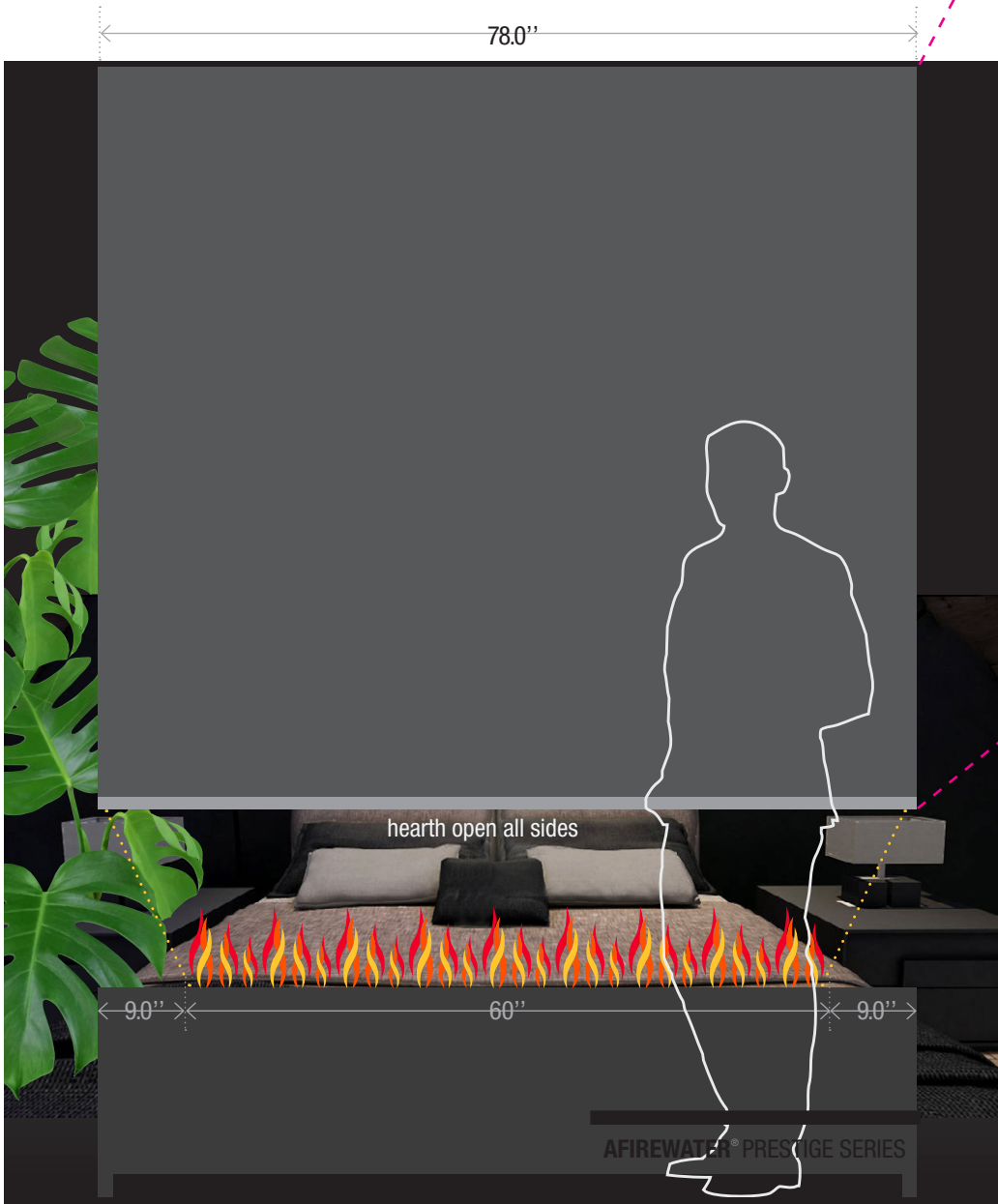

FRONT ELEVATION SCHEMATIC

shown with 60" AWPR Prestige insert set back 9" from each end and 4.15" from front and back (20" deep cabinet) in order to minimize light cast onto ceiling.

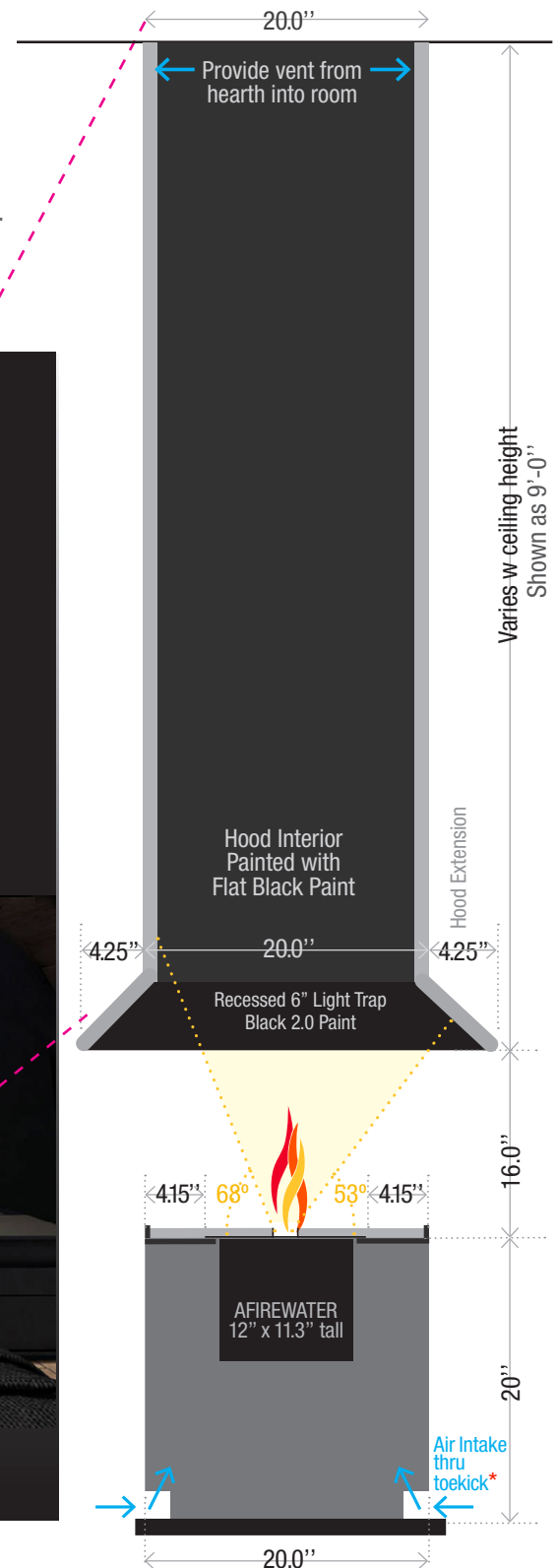

SIDE SECTION SCHEMATIC
OPEN ALL SIDES

INSTALLATION GUIDELINES

TYPICAL LONG MULTIPLE MODULE FIREPLACES

CUTOUT DIMENSIONS REFERENCE Chart: *

20"	AWPR-20-50:	12.25" x 20.2"
40"	AWPR-40-100:	12.25" x 40.2"
60"	AWPR-60-150:	12.25" x 60.2"
80"	AWPR-80-200:	12.25" x 80.3"
100"	AWPR-100-250:	12.25" x 100.3"
120"	AWPR-120-300:	12.25" x 120.3"
140"	AWPR-140-350:	12.25" x 140.3"
160"	AWPR-160-400:	12.25" x 160.3"
180"	AWPR-180-450:	12.25" x 180.3"

(up to 20 feet controlled by one remote)

Minimum Depth of Cutout for all sizes: 11.75"
(when power converter is placed 'beside' insert: front, back, right, or left)

Normal Depth of Cutout for all sizes: 13.62"
(when power converter is placed 'below' insert)

* Note: CUTOUT dimensions are critical!
modules are suspended in opening

PRESTIGE SERIES
80" Fireplace Insert
AWPR 80-200
two (2) AWPR-40-100 40" modules

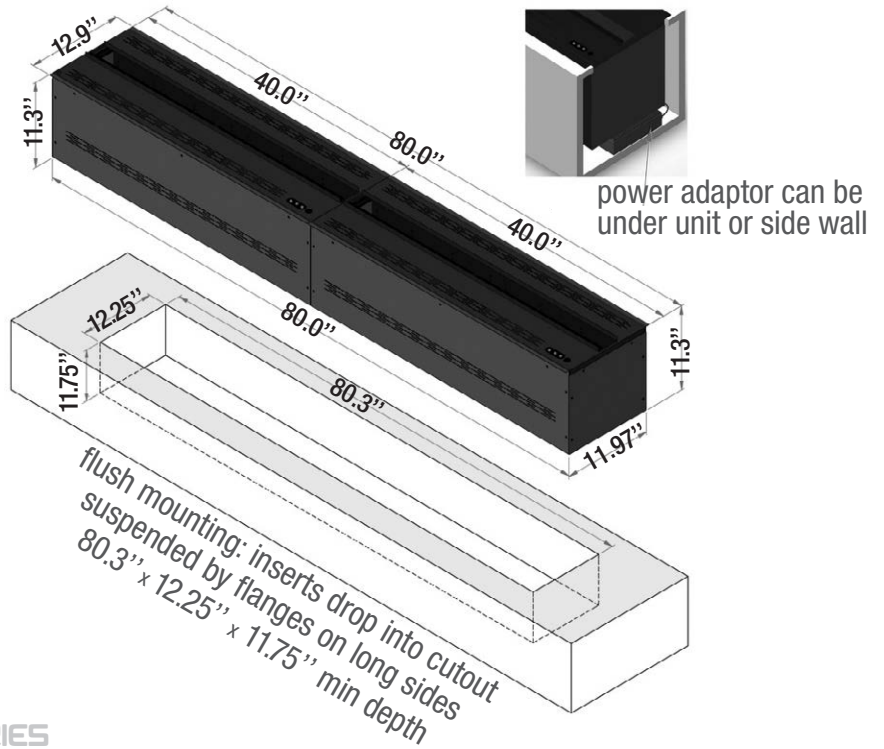

PRESTIGE SERIES
120" Fireplace Insert
AWPR 120-300
two (2) AWPR-60-150 60" modules

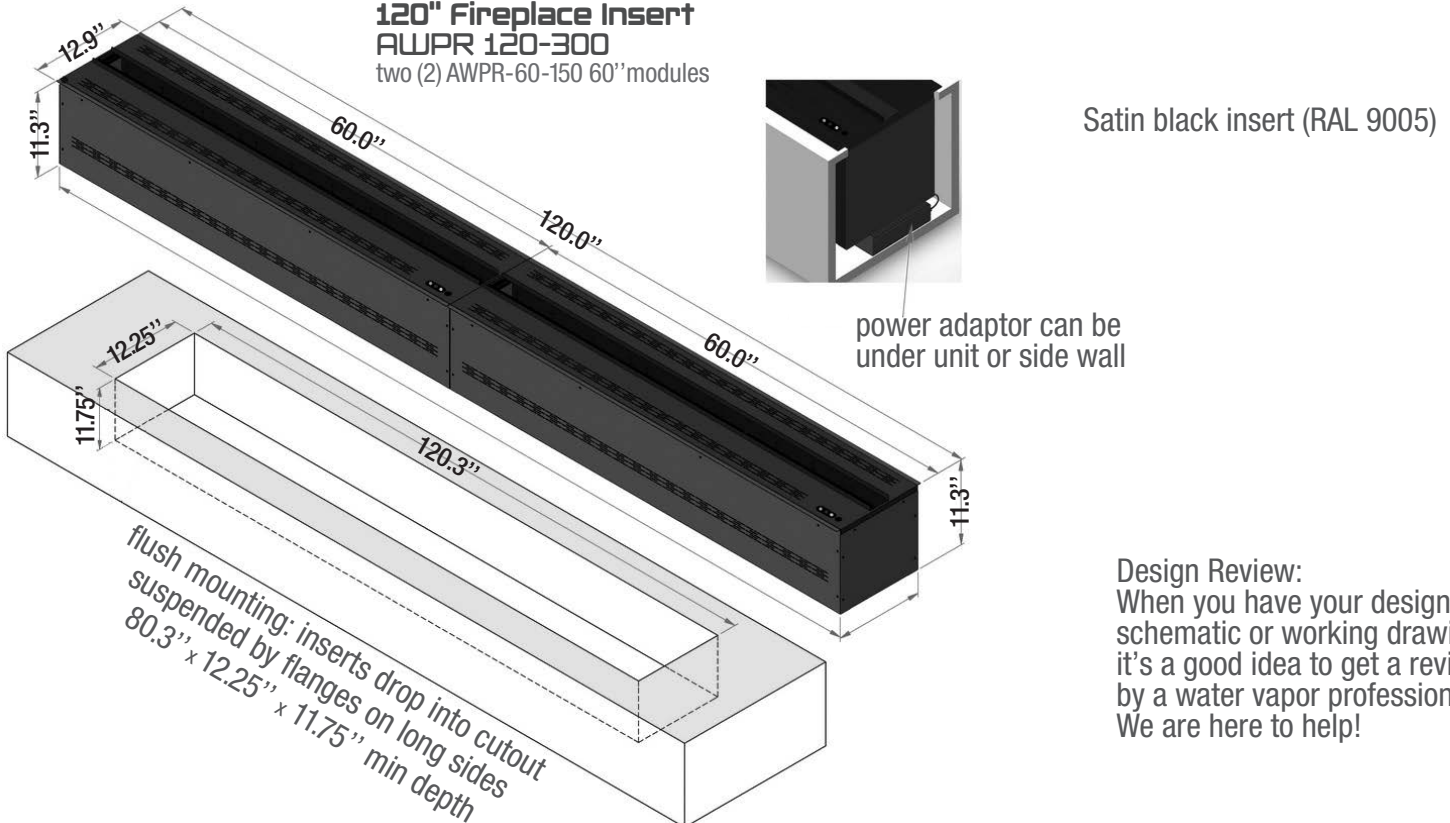

Satin black insert (RAL 9005)

Design Review:
When you have your design schematic or working drawings, it's a good idea to get a review by a water vapor professional. We are here to help!

Finish: Satin Black
RAL 9005
Sherwin Williams

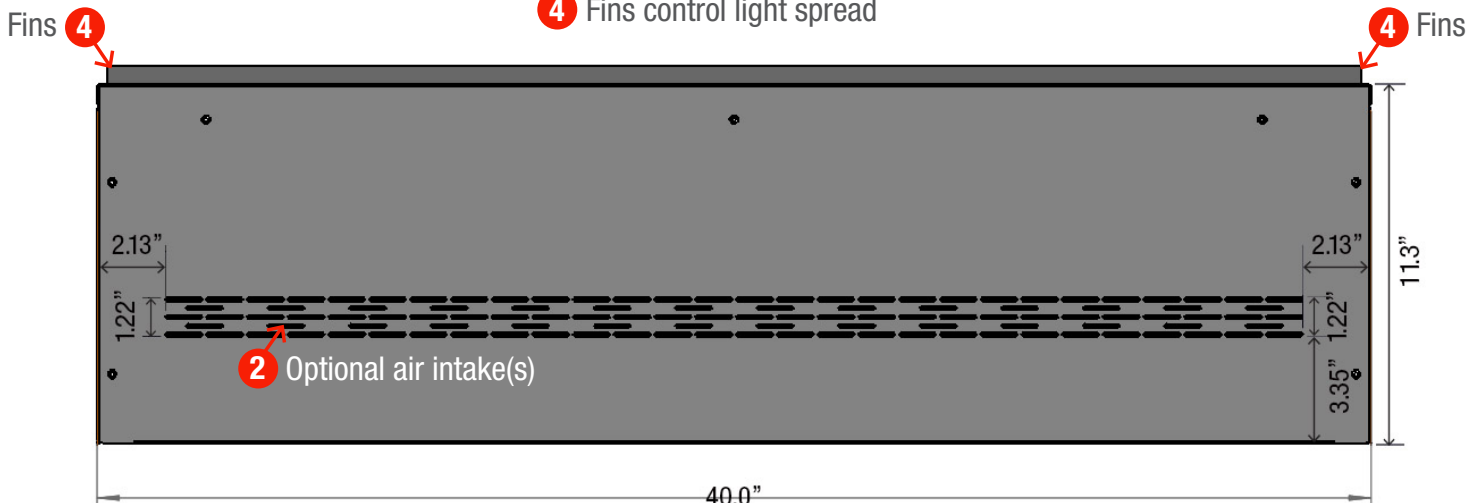
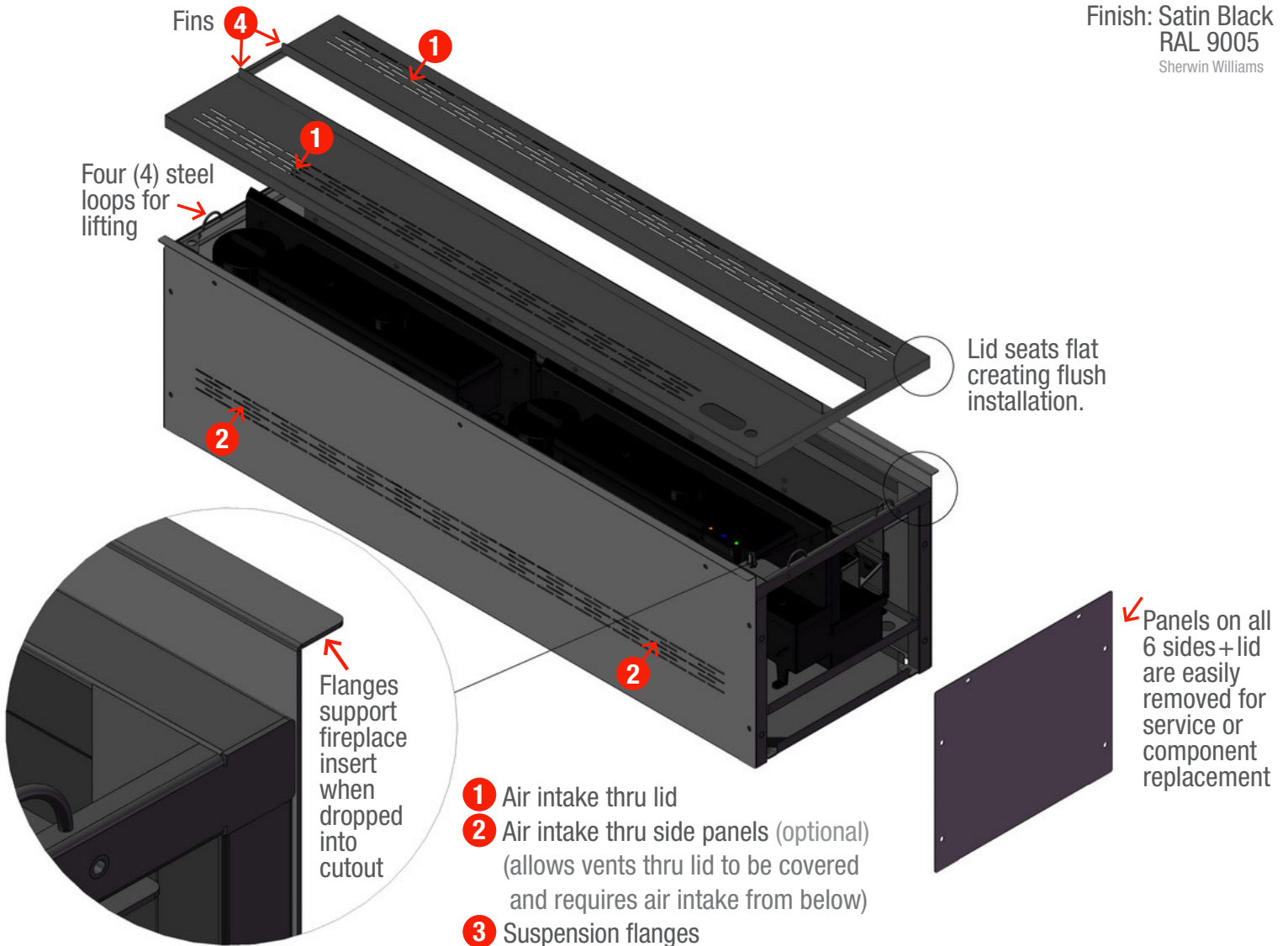

Front Elevation (AWPR 40-100 Prestige Shown)

Water Hardness Areas in the United States

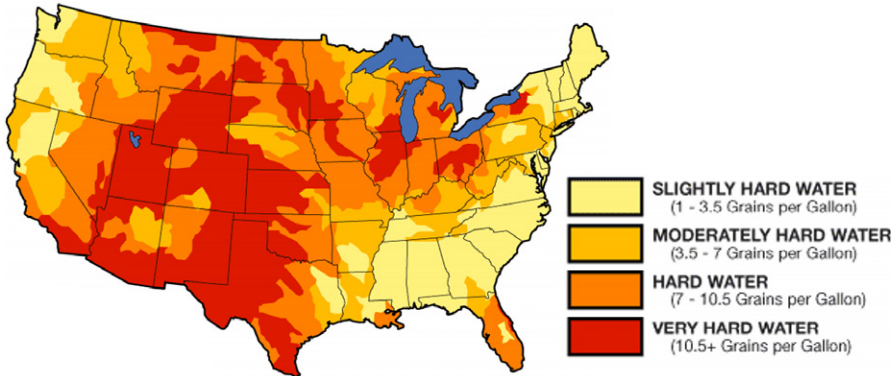

Water Hardness Table of Classifications

grains per gallon (gpg)	milligrams per liter (mg/L) parts per million (ppm)	U.S. Geological Survey Classification	Water Quality Association Classification
< 1.0	< 17.1	soft	soft
1 to 3.5	17.1 to 60	soft	slightly hard
3.5 to 7.0 (ideal)	60 - 120	moderately hard	moderately hard
7.0 to 10.5	120 - 180	hard	hard
10.5 +	180 and over	very hard	very hard



Suggested Range for Water Vapor Fireplaces

3.5 to 8.5 Grains Per Gallon, Ideal is 7.0 (moderately hard)

- Water that is too hard will produce scaling, shorten transducer life, and require more frequent cleaning.
- Water that is too soft will have reduced flame effect.
- If water hardness needs to be adjusted, consult local water conditioning professional.

Hardness Test Kits available on Amazon

REVERSE OSMOSIS is NOT RECOMMENDED, it removes ALL minerals and vapor will be greatly diminished.



CHECKLIST FOR BEST RESULTS: REMEMBER

- protect fireplace insert during construction / dust & debris that gets inside the equipment is a major problem.
- have water tested for water hardness or use a water hardness kit purchased on line.
 - water that is too hard will shorten life of equipment and could void warranty in extreme cases.
 - water without enough minerals (too soft) will greatly limit size and quality of flames.
- flames look best against a dark background.
- drafts from HVAC vents and entrance doors will diminish quality of flames.
- if light cast onto the ceiling of the room is an issue, design a hearth, hood, or light trap to contain the light.
- mist-makers have a life of 2,000 to 3,000 hours and should be cleaned with vinegar 2 to 3 times a year.
- water tanks should be flushed with vinegar and rinsed out with water at least once a year.
- regular cleaning will prolong the life of the fireplace, see recommended Preventive Maintenance Plan.

DESIGN REVIEW

When you have your design schematic or working drawings, it's a good idea to get a review by a water vapor fireplace professional.

...We are here to help!

COMPARISON

AFIREWATER® PRESTIGE SERIES vs AQUAFIRE® SERIES

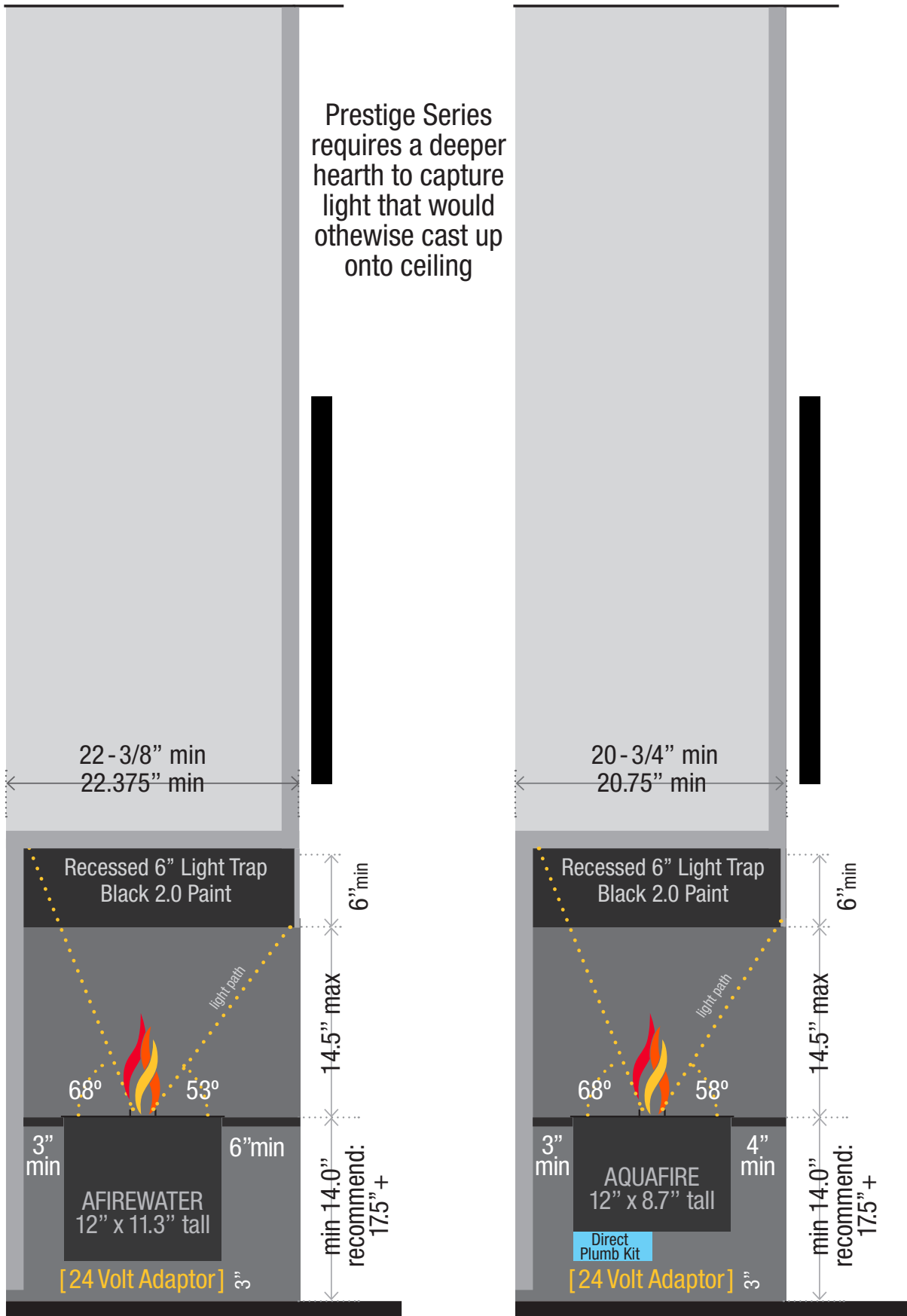

AFIREWATER® PRESTIGE SERIES

AQUAFIRE® SERIES (orange only)

